

納まり例は韓工法を標準に設定しております。

ピュアコアブース メラスクープタイプ

横方向断面図

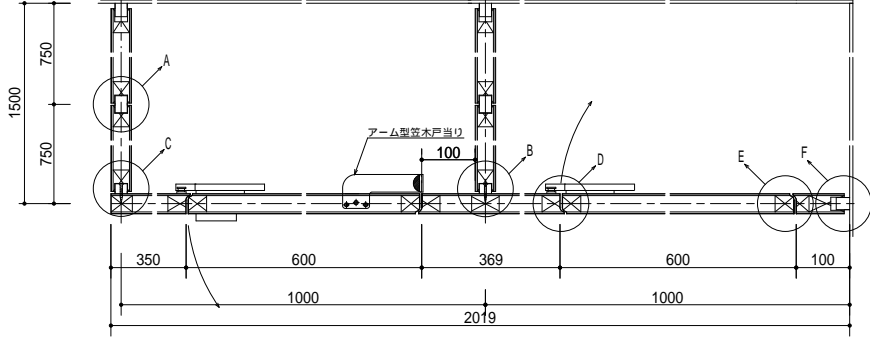

A部

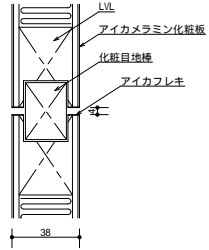

B部

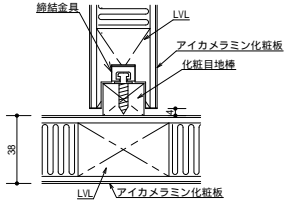

C部

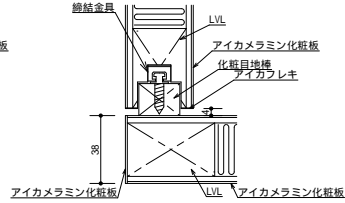

D部

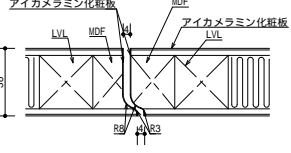

E部

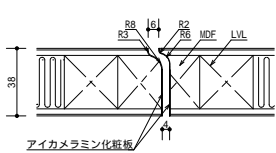

F部

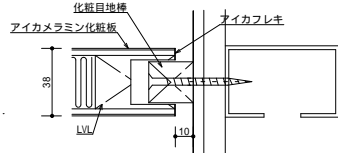

隔て納まり

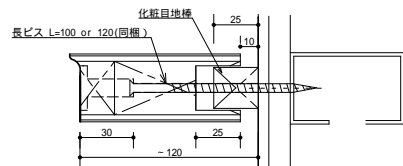
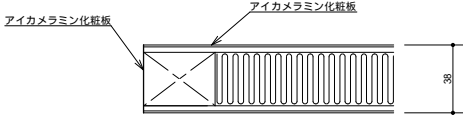

吊元寸法≦120mm以下の場合長ビス固定

外開き仕様

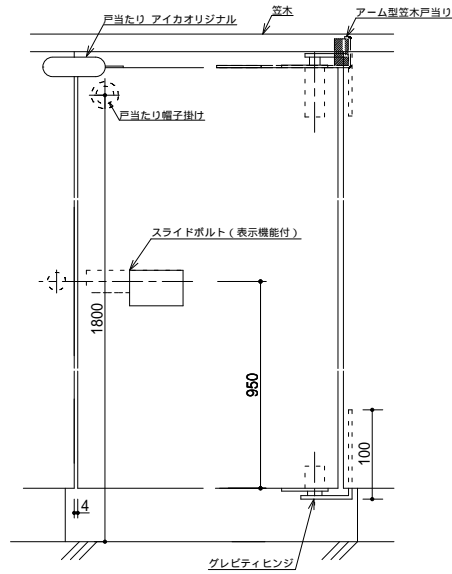

内開き仕様

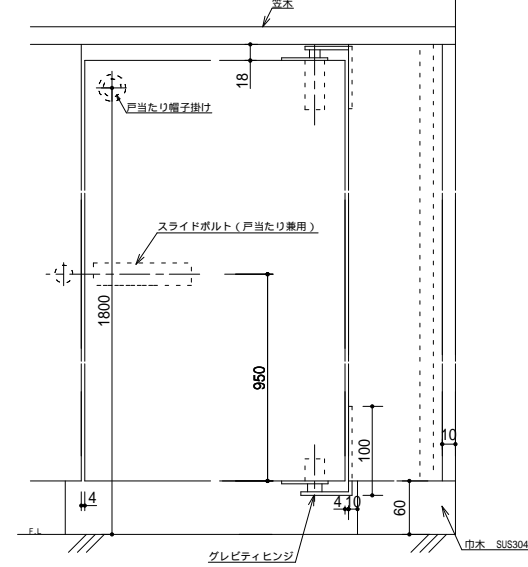

縦方向断面図
笠木仕様

